

CATALOGO DI PRODOTTI

PRODUCT

CATALOGUE



MECCANISMI GIREVOLI 2C Srl.

MECCANISMI GIREVOLI



SWIVEL



MECCANISMI GIREVOLI 2C Srl

MECCANISMI GIREVOLI SWIVEL

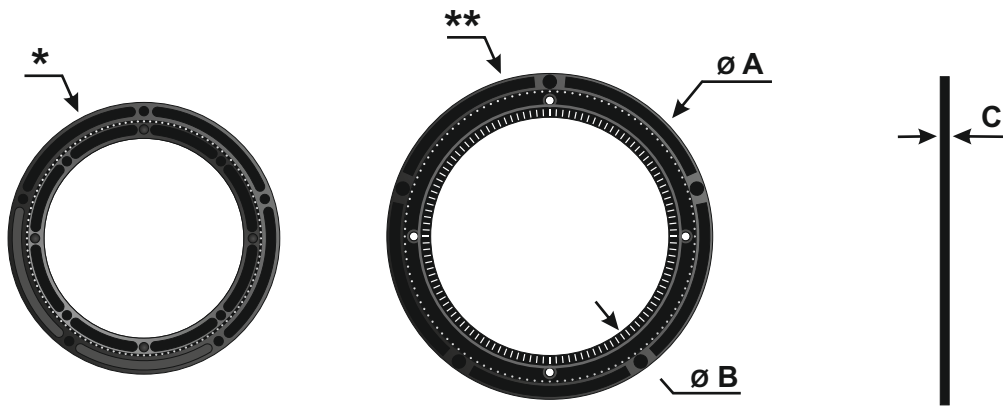

Art.	A	B	C	<u>kg</u>				
DC15INS *	230	167 ±0,2	13,5 ±0,5	200	Plastica Kunststoff Plastic	Nero Schwarz Black	x	x
DC15IES *	230	167 ±0,2	13,5 ±0,5	150	Plastica Kunststoff Plastic	Trasparente Transp. Transp.	x	x
DC19INS **	280	203 ±0,2	14 ±0,5	200	Plastica Kunststoff Plastic	Nero Schwarz Black	x	x
DC19IES **	280	203 ±0,2	14 ±0,5	150	Plastica Kunststoff Plastic	Trasparente Transp. Transp.	x	x

■ Viti / Schrauben / Screw

▲ Biadesivo / Doppelseitigen klebeband / Double-sided adhesive



MECCANISMI GIREVOLI 2C Srl

Meccanismi girevoli in plastica, alluminio e acciaio inox con base rotante per display espositori.

Swivel in plastic, aluminium and stainless steel with rotating basis for displays.

Drehmechanismus aus Kunststoff, Aluminium und Stahl mit Drehsockel für Aussteller

MECCANISMI GIREVOLI SWIVEL

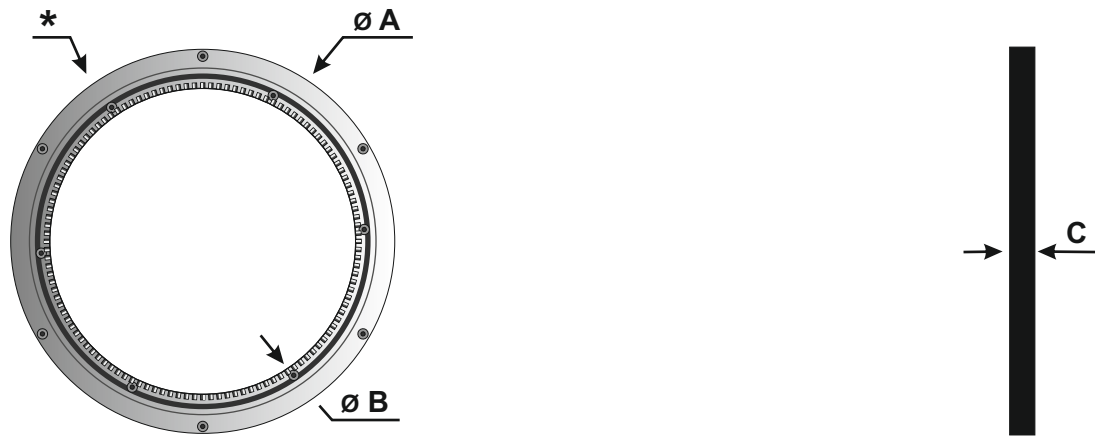

Art.	A	B	C	kg				
DC17INS *	320	261 ±0,3	14,5 ±0,5	300	Al. Al. Al.	Lucido Glaenzend Polished	x	x
DC17ISS *	320	261 ±0,3	14,5 ±0,5	300	Al. Al. Al.	Sabbiato Sandgest. Sandblast.	x	x
DC18INS *	320	261 ±0,3	14,5 ±0,5	300	Al. Al. Al.	Nero Schwarz Black	x	x
DC23BR *	300	231 ±0,3	14 ±0,5	800	Acciaio Stahl Steel	Lucido Glaenzend Polished	x	
DC24BR *	330	264 ±0,3	14 ±0,5	800	Acciaio Stahl Steel	Lucido Glaenzend Polished	x	x

■ Viti / Schrauben / Screw

▲ Biadesivo / Doppelseitigen klebeband / Double-sided adhesive



MECCANISMI GIREVOLI 2C Srl

Meccanismi girevoli in plastica, alluminio e acciaio inox con base rotante per display espositori.
Swivel in plastic, aluminium and stainless steel with rotating basis for displays.

Drehmechanismus aus Kunststoff, Aluminium und Stahl mit Drehsockel für Aussteller

MECCANISMI GIREVOLI SWIVEL

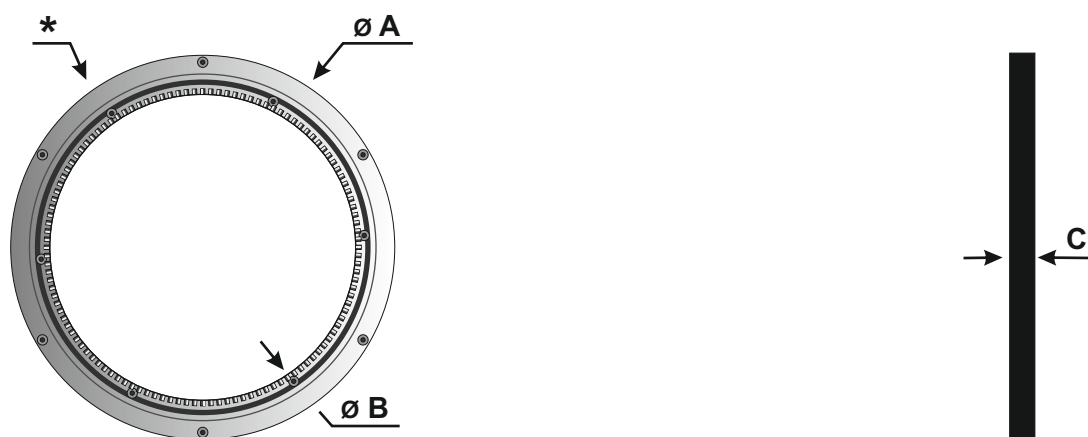

Art.	A	B	C	kg				
ST600S1 *	600	524 ±0,3	16 ±0,5	250	Al. Al. Al.	Sabbiato Sandgest. Sandblast.		
ST798S1 *	798	704 ±0,3	16 ±0,5	300	Al. Al. Al.	Sabbiato Sandgest. Sandblast.		
ST990S1 *	990	890 ±0,3	17 ±0,5	350	Al. Al. Al.	Sabbiato Sandgest. Sandblast.		

■ Viti / Schrauben / Screw

▲ Biadesivo / Doppelseitigen klebeband / Double-sided adhesive



MECCANISMI GIREVOLI 2C Srl

Meccanismi girevoli in plastica, alluminio e acciaio inox con base rotante per display espositori.

Swivel in plastic, aluminium and stainless steel with rotating basis for displays.

Drehmechanismus aus Kunststoff, Aluminium und Stahl mit Drehsockel für Aussteller

MECCANISMI GIREVOLI SWIVEL

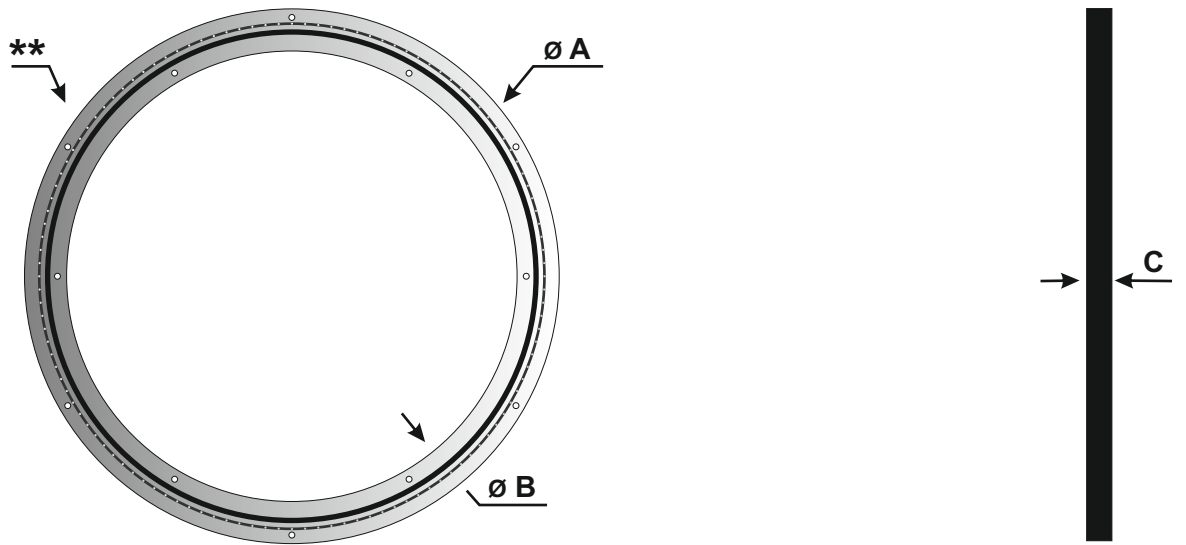

Art.	A	B	C	kg				
DC21INS **	450	382 ±0,5	15 ±0,5	350	Al. Al. Al.	Lucido Glaenzend Polished	x	x
DC21ISS **	450	382 ±0,5	15 ±0,5	350	Al. Al. Al.	Sabbiato Sandgest. Sandblast.	x	x
DC22INS **	450	382 ±0,5	15 ±0,5	350	Al. Al. Al.	Nero Schwarz Black	x	x

■ Viti / Schrauben / Screw

▲ Biadesivo / Doppelseitigen klebeband / Double-sided adhesive



MECCANISMI GIREVOLI 2C Srl





Meccanismi girevoli in plastica, alluminio e acciaio inox con base rotante per display espositori.

Swivel in plastic, aluminium and stainless steel with rotating basis for displays.

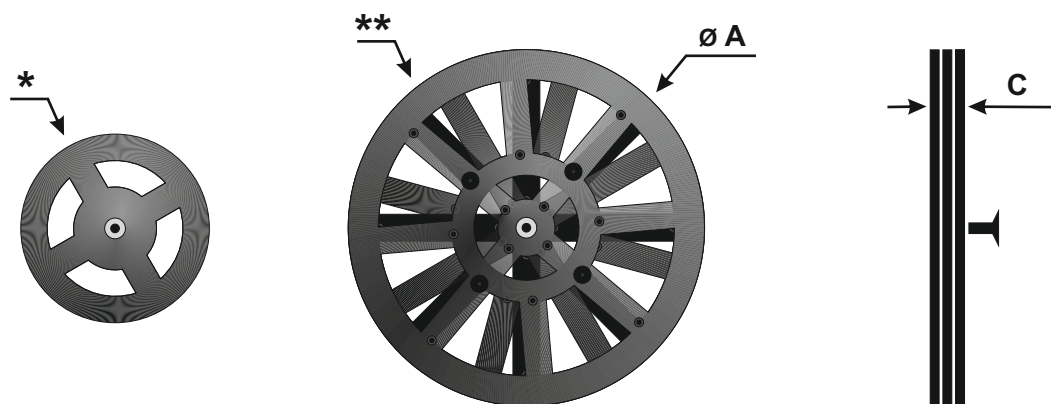
Drehmechanismus aus Kunststoff, Aluminium und Stahl mit Drehsockel für Aussteller

MECCANISMI GIREVOLI SWIVEL



Art.	A		C				
DC14INS *	160	3	8	80	Plastica Kunststoff Plastic	Nero Schwarz Black	x
DC16INS **	300	3	10,8	150	Plastica Kunststoff Plastic	Nero Schwarz Black	x

■ Viti / Schrauben / Screw



Piste / Kugelbahnen / Tracks



MECCANISMI GIREVOLI 2C Srl

Meccanismi girevoli in plastica, alluminio e acciaio inox con base rotante per display espositori.

Swivel in plastic, aluminium and stainless steel with rotating basis for displays.

Drehmechanismus aus Kunststoff, Aluminium und Stahl mit Drehsockel für Aussteller

RUOTE GEMELLATE TWIN WHEEL CASTOR

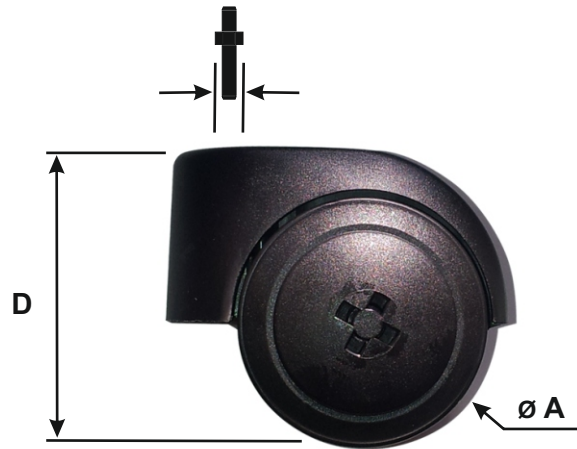

Art.	A	D	kg					
DCLT300NY	50	60	120	Plastica Kunststoff Plastic	Nero Schwarz Black			
DCLT305NY	50	60	120	Plastica Kunststoff Plastic	Nero Schwarz Black	Ø 8X15	X	
DCLT310NY	50	60	120	Plastica Kunststoff Plastic	Nero Schwarz Black	Ø 10X15	X	
DCLT345NY	50	60	120	Plastica Kunststoff Plastic	Nero Schwarz Black	Ø 11X25		X



Misura perno / Stift abmessung / Size stem



Perno filettato / Gewindestift / Threaded stem



Attacco rapido / Einsteckstift / Stem with circlip



MECCANISMI GIREVOLI 2C Srl

Ruote gemellate in plastica per sedie d'ufficio e arredamenti d'interni con perno filettato o attacco rapido.
 Plastic wheels for office chairs and interior furnishings with threaded stem or with circlip.
 Kunststoffräder für Bürostühle und Inneneinrichtung mit Gewindestift oder Einsteckstift.

RUOTE GEMELLATE TWIN WHEEL CASTOR

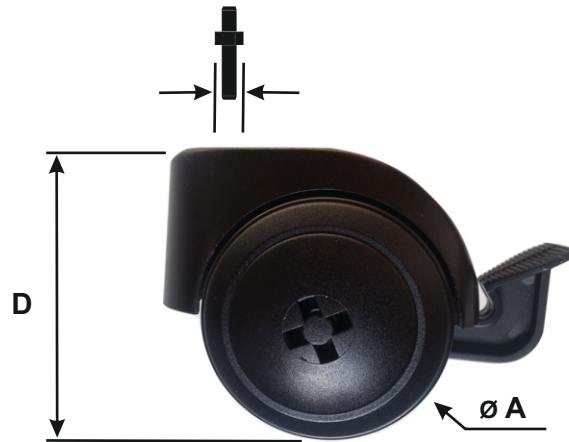

Art.	A	D	kg					
DCLT325NY	50	60	120	Plastica Kunststoff Plastic	Nero Schwarz Black	Ø 8X15	X	
DCLT330NY	50	60	120	Plastica Kunststoff Plastic	Nero Schwarz Black			
DCLT365NY	50	60	120	Plastica Kunststoff Plastic	Nero Schwarz Black	Ø 10X15	X	
DCLT375NY	50	60	120	Plastica Kunststoff Plastic	Nero Schwarz Black	Ø 11X25		X



Misura perno / Stift abmessung / Size stem



Perno filettato / Gewindestift / Threaded stem



Attacco rapido / Einsteckstift / Stem with circlip



MECCANISMI GIREVOLI 2C Srl

Ruote gemellate in plastica per sedie d'ufficio e arredamenti d'interni con perno filettato o attacco rapido.
 Plastic wheels for office chairs and interior furnishings with threaded stem or with circlip.
 Kunststoffräder für Bürostühle und Inneneinrichtung mit Gewindestift oder Einsteckstift.

ROLLY KIT

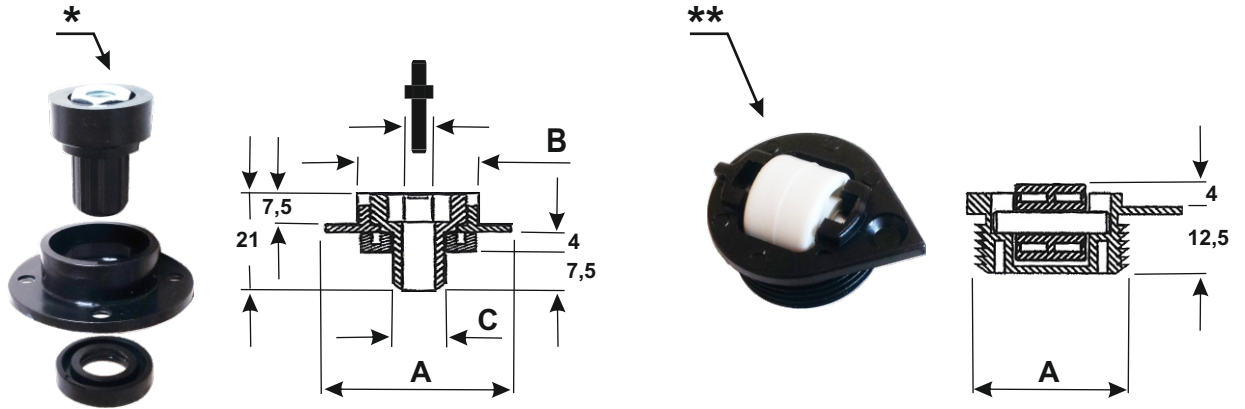

Art.	A	B	C			
DC11INS *	$\varnothing 35 \pm 0,5$	$\varnothing 22$	$\varnothing 10$	Plastica Kunststoff Plastic	Nero Schwarz Black	
DC12INS **	$\varnothing 22,5 \pm 0,3$			Plastica Kunststoff Plastic	Nero Schwarz Black	25
DC13INS [DC11INS x 1] + [DC12INS x 4]				Plastica Kunststoff Plastic	Nero Schwarz Black	100

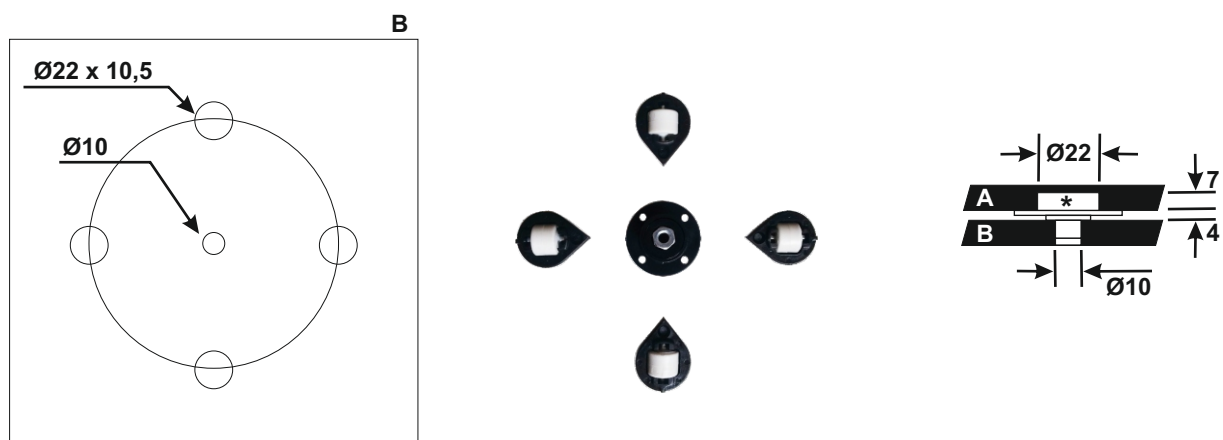



MECCANISMI GIREVOLI 2C Srl

Meccanismo di rotazione e scorrimento Rolly Kit: portata di 100 Kg.
 Rotation mechanism and sliding Rolly Kit: carrying capacity of 100 kg.
 Drehmechanismus und Schiebe Rolly Kit: Tragkraft von 100 kg.

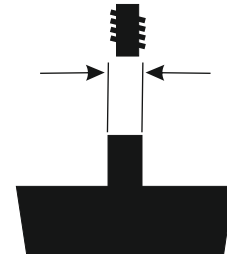
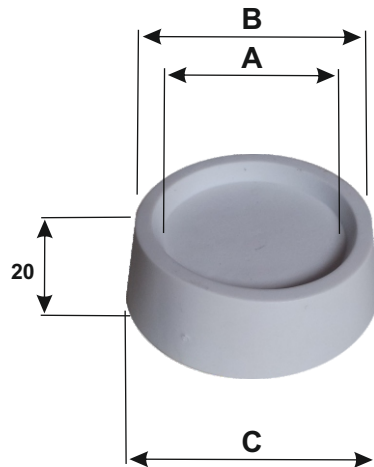
PIEDINI AMMORTIZZANTI SHOCK ABSORBING PADS



Art.		A	B	C	Shore A±3°		
PAV45B							
PAV45B8 *							
PAV45B10 *							
PAV45B12 *							
PAV45A *		Ø 45	Ø 58	Ø 64	70	Plastica Kunststoff Plastic	Argento Silber Silver Ral 7001
PAV45A8 *	M8 x15						
PAV45A10 *	M10 x15						
PAV45A12 *	M12 x15						
PAV45M *		Ø 45	Ø 58	Ø 64	70	Plastica Kunststoff Plastic	Marrone Braun Brown Ral 1011
PAV45M8 *	M8 x15						
PAV45M10 *	M10 x15						
PAV45M12 *	M12 x15						

* : Colori e dimensioni perni a richiesta / Customized colors & stems on request / Farbe und Gewindestift nach Anfrage



MECCANISMI GIREVOLI 2C Srl

Piedini ammortizzanti in gomma shore 70 con colori e perni a richiesta.
Shock-absorbing rubber shore 70 feet with pins and colors on request.
Stoßdämpfende Gummi Ufer 70 Fuß mit Stiften und Farben auf Anfrage.

GANCI HOOKS

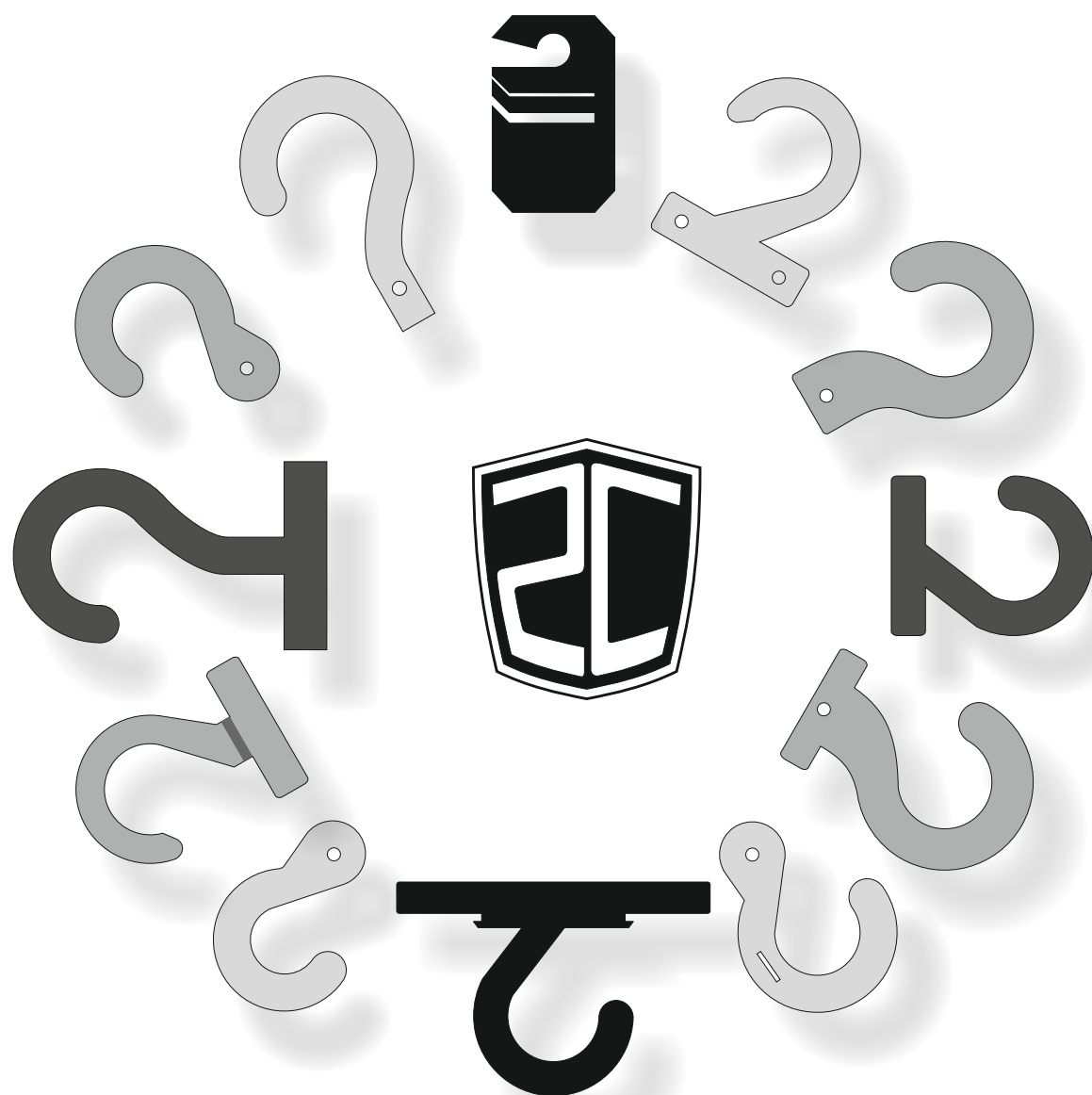

MECCANISMI GIREVOLI 2C Srl

GANCI HOOKS

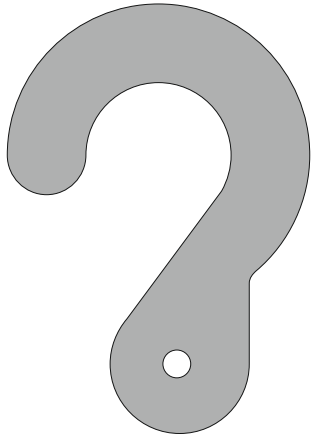

Cod. H1
70x50mm



Cod. H2
75x55mm



Cod. H2A
75x55mm



Cod. H3
85x60mm



Cod. H3A
85x60mm



MECCANISMI GIREVOLI 2C Srl

Ganci in plastica per i display dell'industria dell'abbigliamento
Plastic hooks for display of clothing industry
Kunststoff-Haken für die Anzeige der Bekleidungsindustrie

GANCI HOOKS



Cod. H4
70x55mm

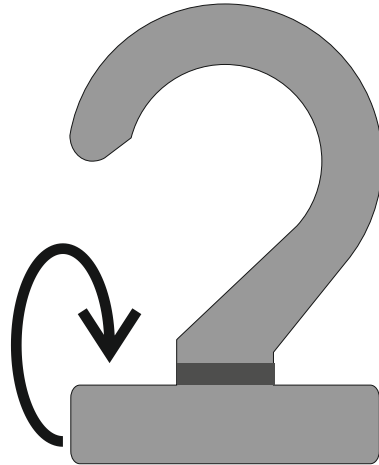

Cod. H4A
76x55mm



Cod. H5
70x55mm



Cod. H5A
75x110mm



MECCANISMI GIREVOLI 2C Srl

Ganci in plastica per i display dell'industria dell'abbigliamento
Plastic hooks for display of clothing industry
Kunststoff-Haken für die Anzeige der Bekleidungsindustrie

GANCI HOOKS

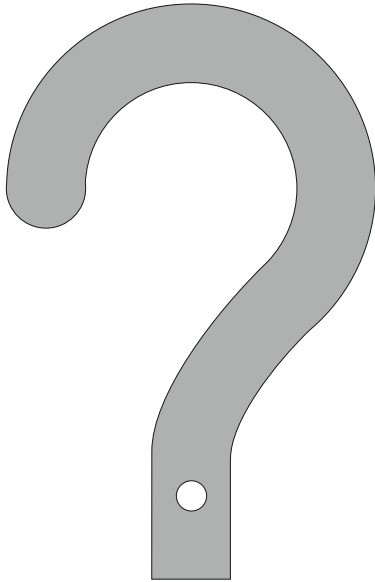

Cod. H6
90x60mm



Cod. H6A
100x65mm



Cod. H7
70x45mm

Colori a richiesta / Customized colors on request



MECCANISMI GIREVOLI 2C Srl

Ganci in plastica per i display dell'industria dell'abbigliamento
Plastic hooks for display of clothing industry
Kunststoff-Haken für die Anzeige der Bekleidungsindustrie

TAPPI



BOTTLECOVERS



MECCANISMI GIREVOLI 2C Srl

TAPPI BOTTLE COVERS



Cod. 002BCSFSM
diam. Ext. 29,5 x 28



Cod. 002BCCISM
diam. Ext. 28 x 31



Cod. 002BCSPMT
diam. Ext. 31,5 x 42



Cod. 002BCCILA
diam. Ext. 27 x 41

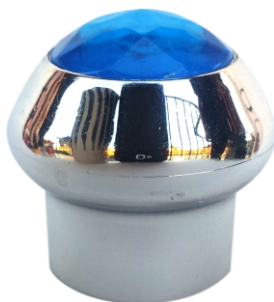

Cod. BCSFGM
diam. Ext. 36 x 36



Cod. 002BCCITO
diam. Ext. 24,5 x 32

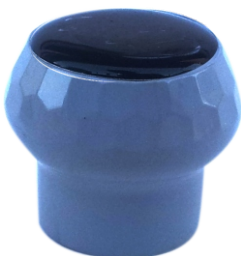

Cod. 002BCCACR
diam. Ext. 32 x 28



Cod. 002BCNU
diam. Ext. 30 x 32

ALL BOTTLE COVERS:  FEA 15  On request



MECCANISMI GIREVOLI 2C Srl

Tappi in plastica per bottiglie di profumo con attacco a baionetta FEA 15 e finitura personalizzata a richiesta del cliente.
Plastic caps for perfume bottles with bayonet FEA 15 and custom finish to customer request.
Kunststoffkappen für die Parfüm-Flaschen mit Bajonett FEA 15 und Custom Finish Kundenwunsch.

TAPPI BOTTLE COVERS



Cod. 002BCCR04
diam. Ext. 31 x 30



Cod. 002BCSEN
diam. Ext. 29 x 30



Cod. 002BCCH01
diam. Ext. 35 x 27



Cod. 002BCCH02
diam. Ext. 42 x 31



Cod. 002BCCIC
diam. Ext. 20 x 21

ALL BOTTLE COVERS:  FEA 15  On request



MECCANISMI GIREVOLI 2C Srl

Tappi in plastica per bottiglie di profumo con attacco a baionetta FEA 15 e finitura personalizzata a richiesta del cliente.
Plastic caps for perfume bottles with bayonet FEA 15 and custom finish to customer request.
Kunststoffkappen für die Parfüm-Flaschen mit Bajonett FEA 15 und Custom Finish Kundenwunsch.

TAPPI BOTTLE COVERS

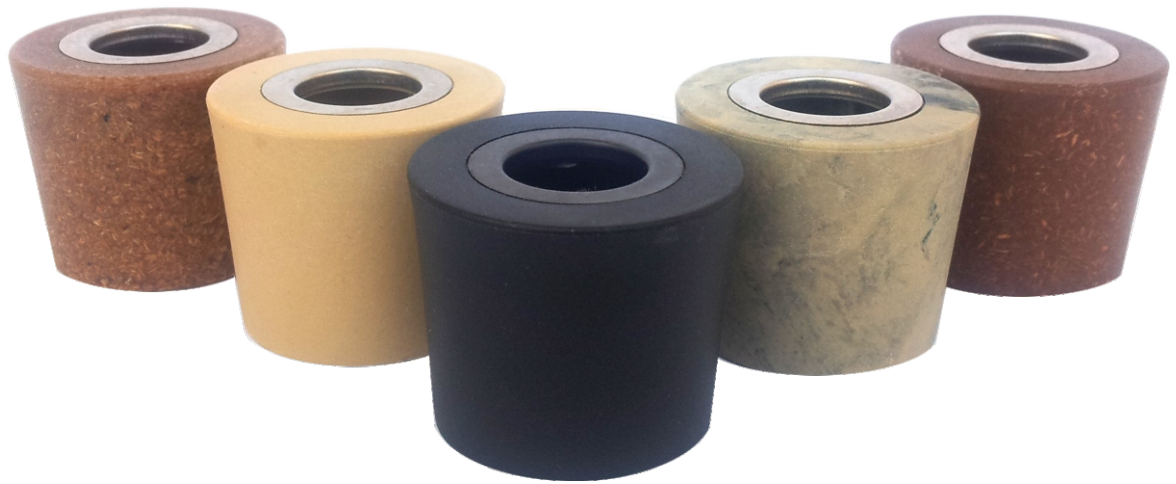

MECCANISMI GIREVOLI 2C Srl

TAPPI BOTTLE COVERS



A.
diam. Ext. 32 x 28

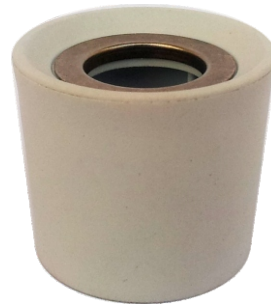

D.
diam. Ext. 35 x 30



B.
diam. Ext. 38 x 32



B.
diam. Ext. 46 x 49



C.
diam. Ext. 45 x 20

ALL BOTTLE COVERS:  FEA 15  On request



MECCANISMI GIREVOLI 2C Srl

Tappi in plastica per ambientatori con anello metallico, attacco a pressione e a vite. FEA e finitura personalizzata a richiesta.
Plastic caps for environment deodorants with iron ring, pressure clip or screw. FEA and custom finish on request.
Kunststoffkappen für die Umwelt Deodorants mit Eisenring, Druck Clip oder Schraube.

ARTICOLI TECNICI

TECHNICAL ITEMS



MECCANISMI GIREVOLI 2C Srl

ARTICOLI TECNICI TECHNICAL ITEMS

ANELLI IN FERRO | IRON RINGS

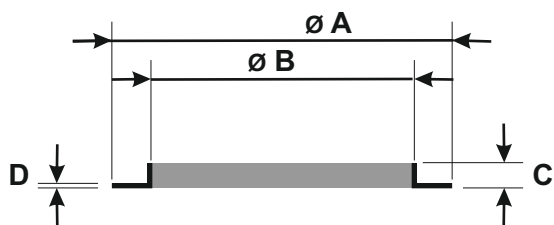

Art.	A	B	C	E	
An22ni	22	13	2	0,3	Ni
A22br	22	13	2	0,3	Br
An24ni	24	15	2	0,3	Ni
An24br	24	15	2	0,3	Br
An27ni	27	19	2,5	0,3	Ni
An27br	27	19	2,5	0,3	Br
An45ni	45	35	3	0,5	Ni
An45br	45	35	3	0,5	Br

Ni: Nichelato bianco / White nickel Nickel weiß
 Br: Nichelato imbrunito / Brown nichel / Braun Zinc

GIUNTO SNODABILE



Cod. 14GSNI01
 11SMn30
 Ferro zincato
 Passo filetto M8x11



MECCANISMI GIREVOLI 2C Srl

Anelli in ferro con zincatura bianca o imbrunita | giunto snodabile in ferro zincato
 Iron rings with white zinc or brown | joint in galvanized iron
 Eisenringe mit weißer Zink oder braun | Gelenk in verzinktem Eisen

Una ditta nuova con esperienza trentennale

Oltre trent'anni di attività sul campo fanno di noi una società giovane ma al contempo dotata di una lunga tradizione ed una consolidata esperienza.

A partire dai servizi per il mercato dell'arredamento, il nostro business si è rapidamente espanso facendo tesoro della competenza maturata nella produzione di stampi, stampaggio materie plastiche e assemblaggio nei settori automotive, cosmetica, abbigliamento e zootecnico. La nostra storia è testimonianza di passione, onestà e ambizione

La costante presenza della proprietà ci garantisce una adeguata gestione aziendale in termini di correttezza dei rapporti, attenzione ai costi/ricavi e sensibilità ai contenuti qualitativi.
Le esigenze del cliente sono al centro delle nostre attenzioni e ci sforziamo di offrire un servizio a 360°.

A new company with experience of more than thirty years

Over thirty years of activity in the field make us a young company but at the same time with a long tradition and extensive experience.

From the service to the furniture market, our business has expanded rapidly by building on the expertise gained in the manufacture of molds, plastic molding and assembly in the automotive, cosmetics, clothing and livestock. Our history is testimony to passion, honesty and ambition

The constant presence of the property gives us a proper business management in terms of correct relationships, attention to costs / revenues and sensitivity to content quality.
Customer needs are the focus of our attention and we strive to offer a 360° service.

Ein neues Unternehmen mit 30 Jahre Erfahrung

Mehr als dreißig Jahren Tätigkeit auf dem Gebiet machen uns ein junges Unternehmen, aber zur gleichen Zeit mit einer langen Tradition und langjährige Erfahrung.

Vom Dienst an der Möbelmarkt hat sich unser Geschäft schnell, indem wir auf das Know-how in der Herstellung von Formen, Kunststoff-Spritzgießen und Montage in der Automobilindustrie, Kosmetik, Kleidung und Viehzucht gewonnen erweitert. Unsere Geschichte ist ein Beweis für die Leidenschaft, Ehrlichkeit und Ehrgeiz

Die ständige Präsenz des Grundstücks gibt uns eine ordnungsgemäße Unternehmensführung in Bezug auf die richtigen Beziehungen, Liebe zum Kosten / Erlöse und die Sensibilität für die Qualität der Inhalte.
Die Bedürfnisse der Kunden stehen im Mittelpunkt unserer Aufmerksamkeit, und wir bemühen uns, eine 360° Service zu bieten.



MECCANISMI GIREVOLI 2C Srl

Sede Legale: Via San Luca 10, 20122 Milano Italia | Sede Operativa: Via Cereé 10, 22070 Beregazzo con Figliaro Co Italia
Tel/Fax Infitalia: + 0039 031 988 275 | info@2c-srl.it | http://www.2c-srl.it | P. IVA C.F. It07938130965
Tel Export: +39 0396 081925 | Fax export: +39 0398 947969 | export@2c-srl.it